

Chofu Commissioning Guide

Commissioning Guide

This document must be read in association with the Chofu Installation Manual provided with the unit. It is essential the manual is read and followed to ensure the installation is as per manufacturer's criteria. The purpose of this document is to assist with the commissioning of the heat pump parameters and the connection of third party controls.

Contents

Pre-Commissioning

Pre-Commissioning Checks	4
Filling the System with Water	4
Heat Pump Controller	5

Room Thermostat Connection

Room Thermostat Connection	6
Heating and Cooling Changeover	6

Heat Pump Controller Settings

Heat Pump Controller Settings	7
-------------------------------------	---

Heating Only System Configurations

System 1: Heat Pump Switched On/Off by Room Thermostat(s) Heating Only	8
System 2: Heat Pump Switched On/Off by Room Thermostat(s), Heating Only + DHW	9

Heating & Cooling System Configurations

Selecting The Correct Cooling Option	10
System 3-A: Heat Pump Switched On/Off by Room Thermostat(s) Heating & Type A Cooling	11
System 3-B: Heat Pump Switched On/Off by Room Thermostat(s) Heating & Type B Cooling	12-13
System 4-A: Heat Pump Switched On/Off by Room Thermostat(s), Heating & Type A Cooling + DHW	14-15
System 4-B: Heat Pump Switched On/Off by Room Thermostat(s), Heating & Type B Cooling + DHW	16-17

System Operational Checks

Checking Sensor Values	18
------------------------------	----

Resetting Errors

Resetting Errors	19
------------------------	----

Additional Information

Additional Information	19
------------------------------	----

Pre-Commissioning

Pre-Commissioning Checks

Prior to Filling with water

A: Ensure the heat pump is installed in accordance with the installation manual.

B: Ensure the power is isolated to the unit.

C: Remove the side cover of the unit to expose the water pump, compressor and electrical enclosure.

D: Check the pre-charge of the expansion vessel is set to 1 bar.

Filling the System with Water

Thoroughly flush the system with a flushing cart or suitable mains pressure, until there is no sign of air returning through the primary feed pipes. This will remove most of the air from the system. Now pressurise the system to 1 Bar on the heat pumps pressure gauge. The heat pump has a pump run switch on the terminal PCB under the side cover of the heat pump. This allows the circulation pump to be run manually to help fully vent the system of air. Ensure the automatic air vents in the system are open.

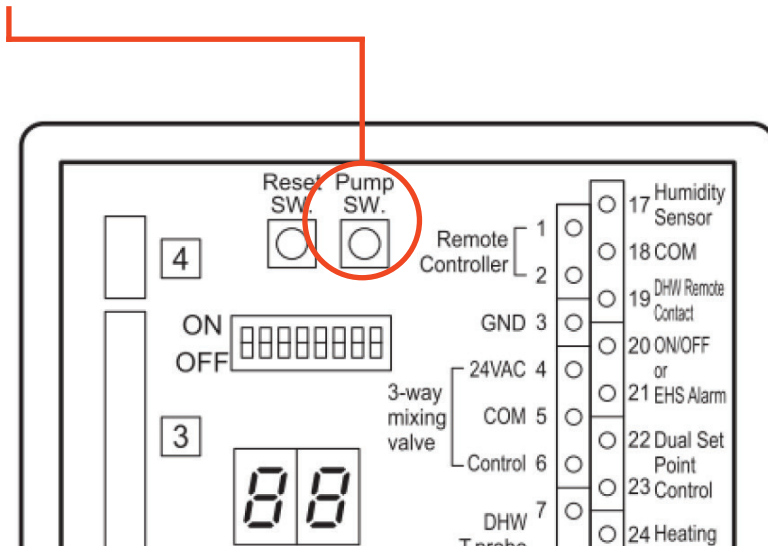

Heat Pump Controller (connection)

The Chofu heat pump controller must be installed to manage the heat pump operation. The controller is not rated for outdoor use, installation indoors in a dry place is recommended; i.e. garage or service cupboard.

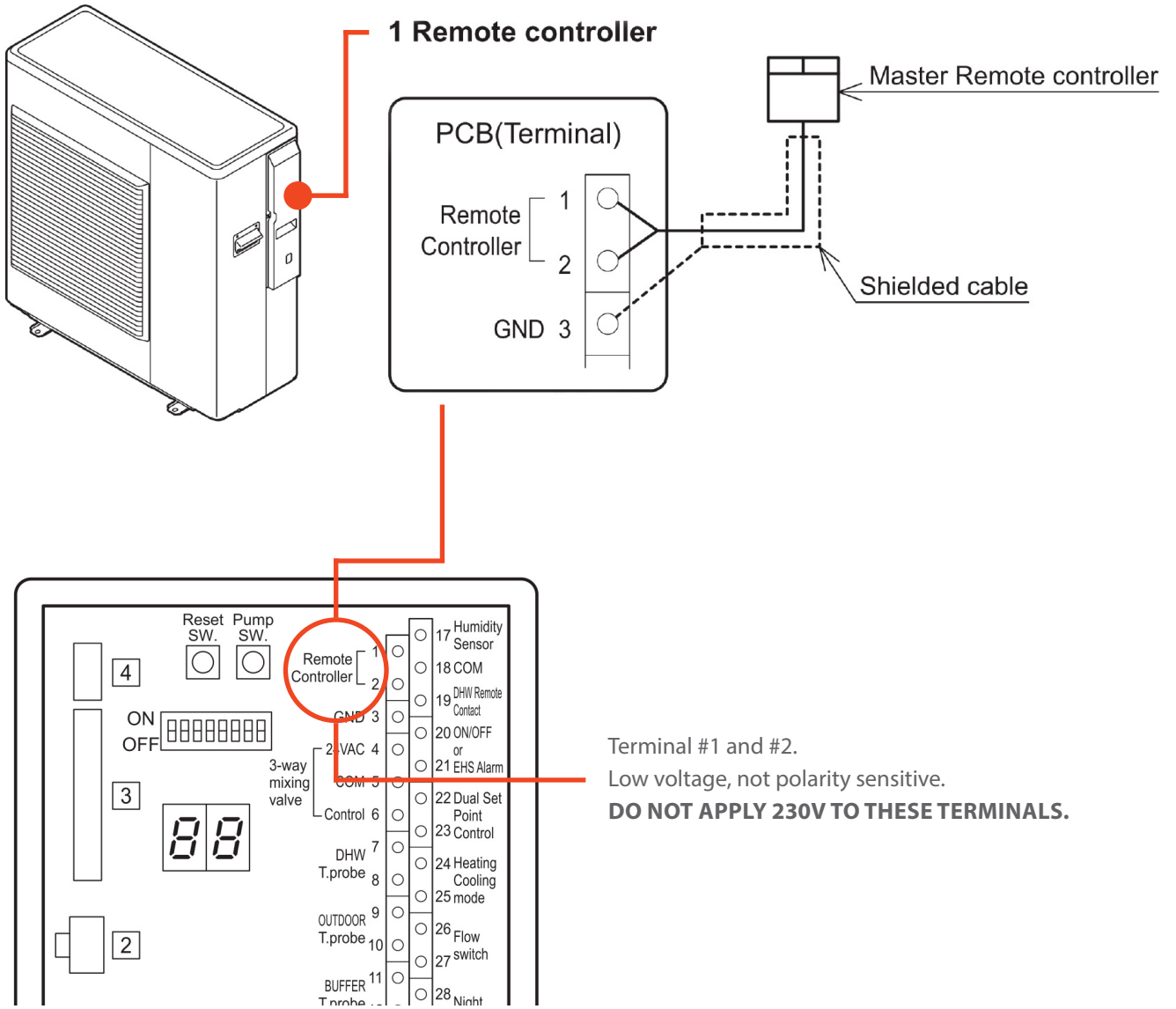

Room Thermostat Connection (remote contact)

Connect room thermostat wiring to terminals #20, #21 via the normally open contacts of the room thermostat. The thermostat requires volt free contacts to open/close terminals #20, #21. If the thermostat features a switched live output for on/off, an external relay with volt free contacts will need to be used. Open contacts = Off; Closed contacts = On. These terminals are enabled when changing parameter 5120. See system configuration for more details.

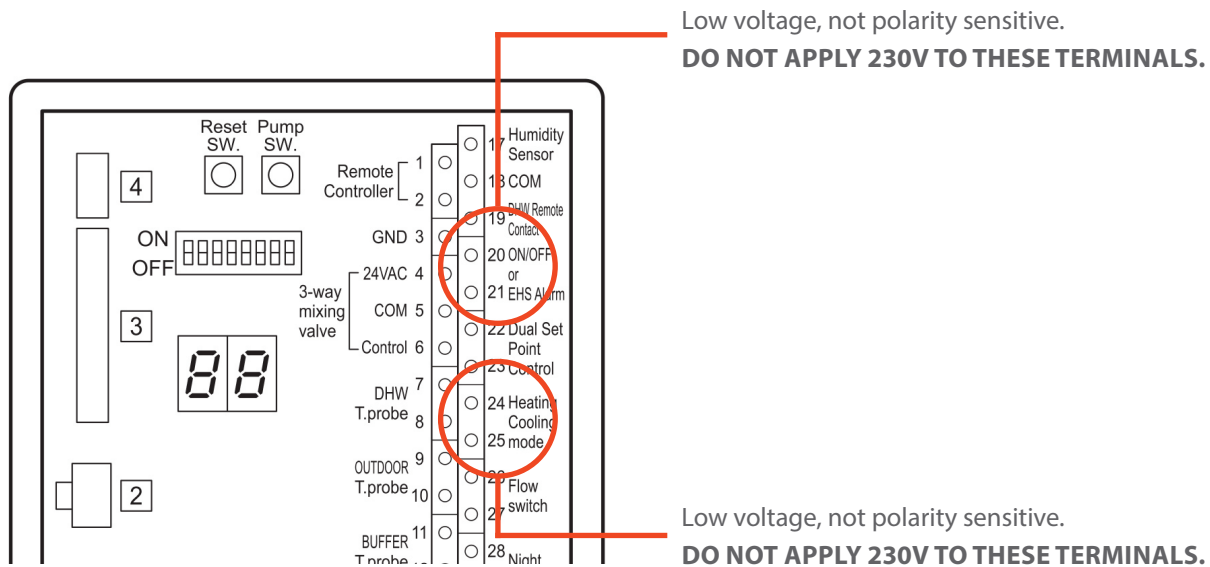

Heating and Cooling changeover



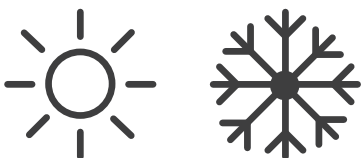











If your room thermostat has heating and cooling functionality it can change the operating mode of the heat pump. Connect the thermostat changeover wiring to terminals #24, #25 via the normally open contacts of the room thermostat. The thermostat requires volt free contacts to open/close terminals #24, #25. If the thermostat features a switched live output for changeover, an external relay with volt free contacts will need to be used. Open contacts = Heating; Closed contacts = Cooling. These terminals are enabled when changing parameter 5124. See system configuration for more details.



Heat Pump Controller Settings



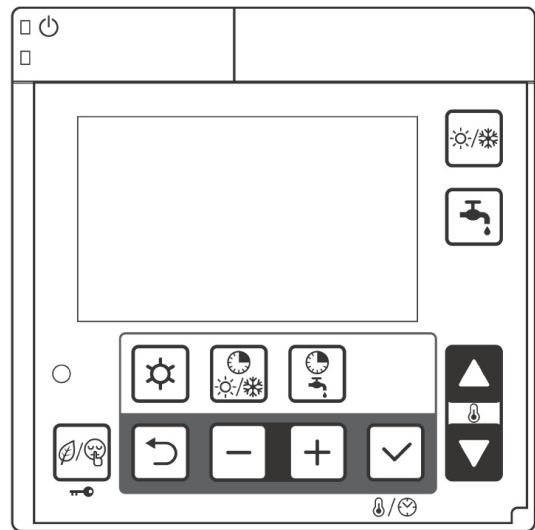

The heat pump controller must be installed to manage and configure control parameters.

For install level

1. For **Install** parameters hold down the 3 buttons    together for 3 seconds.
2. The parameter number (4 digits) will be displayed, and the value of the parameter. (2 of the 4 parameter digits will be flashing).
3. Change these (flashing) numbers using the Up/Down buttons,  or 
4. Change to the other 2 digits using the +/- buttons,  or  and changes these too if necessary.
5. Press the Set button 
6. The parameter value will now flash.
7. Change value using the  or  buttons.
8. Press the Set button  to confirm the new value.
9. To default back to the main menu, press    together for 3 seconds. The controller will default back to the main menu screen.



For service level

1. Press the Menu,  and  buttons simultaneously for 3 seconds. The **INSTALLER** level setting menu will be displayed.
1. Enter the password to access the **SERVICE** level, specify parameter number "9999" and enter password "738", and press the Set button to confirm entry of the password.
1. "SErv" (means **SERVICE**) will be displayed in the position of room temperature display. In **SERVICE** level, all parameters can be accessed. The procedures of setting parameters are same as **INSTALLER** level.
2. To return to normal operation, press and hold the Menu,  and  for 3 seconds, or simply do nothing for approximately 10 minutes.

Procedure for resetting parameters

In **SERVICE** level, all parameters can be reset to the default when the LOW tariff/ Night mode button is pressed and held for 10 seconds.

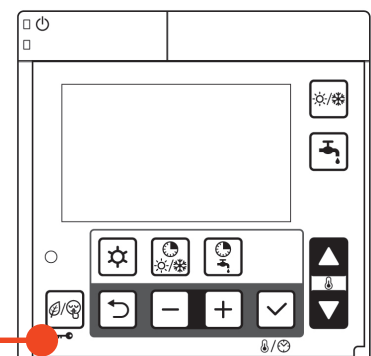

03/22-V4

System Configuration

The following is a list of common configurations that are typically used. If you require something specific to your installation please contact us for a tailored list of parameters.

System 1: Heat Pump Switched On/Off by Room Thermostat(s) Heating Only

System 2: Heat Pump Switched On/Off by Room Thermostat(s) Heating + DHW

System 3: Heat Pump Switched On/Off by Room Thermostat(s) Heating & Cooling

System 4: Heat Pump Switched On/Off by Room Thermostat(s) Heating & Cooling + DHW

System 1: Heat Pump Switched On/Off by Room Thermostat(s) Heating Only

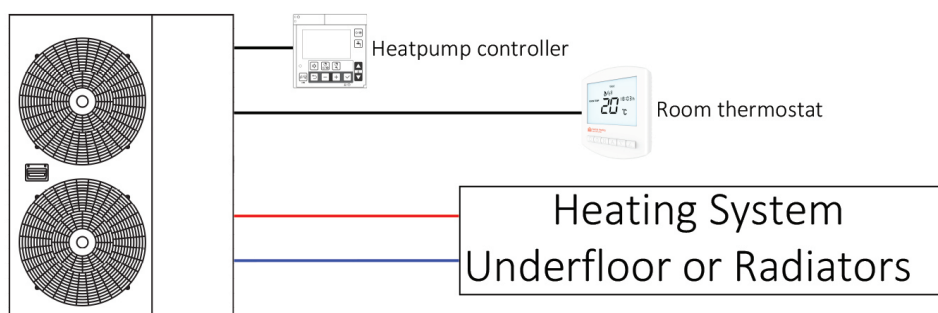

Parameter	Description	Value	
		Default	Set To
2101	Flow temperature set point for heating 35 to 45 underfloor (depending on floor covering) 60 – radiators	45	See description
4301	Start temp of frost protection on room air temperature	14	5
5120	Terminal 20-21: On/Off remote contact or EHS Alarm input 0 = Disable (Remote controller only) 1 = On/Off remote contact 2 = EHS Alarm input	0	1
5126	Flow switch input, terminals 26-27: 0 = Disable 1 = Enable	1	0

System 2: Heat Pump Switched On/Off by Room Thermostat(s) Heating + DHW

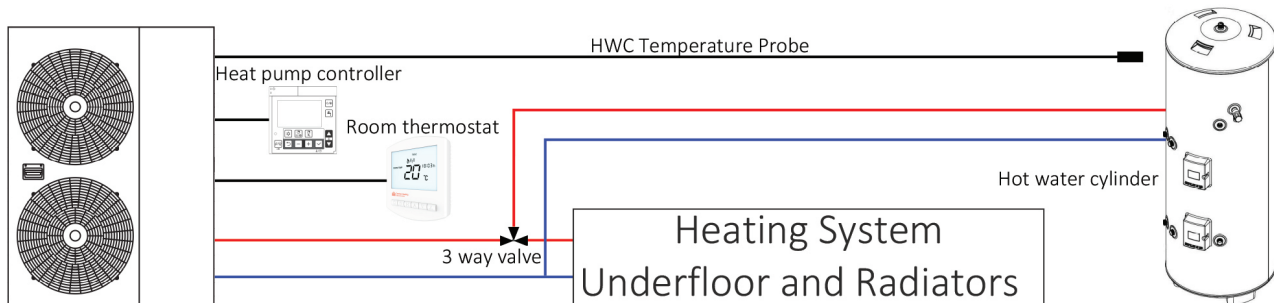

Parameter	Description	Value	
		Default	Set To
2101	Flow temperature set point for heating 35 to 45 underfloor (depending on floor covering) 60 – radiators	45	See description
3101	0 = DHW is unavailable 1 = DHW is available, and priority DHW over space heating	0	1
3111	DHW set temperature (of water in cylinder)	50	50
4301	Start temp of frost protection on room air temperature	14	5
5107	Enable DHW sensor: Terminal 7-8 0 = Disable 1 = Enable	0	1
5120	Terminal 20-21: On/Off remote contact or EHS Alarm input 0 = Disable (Remote controller only) 1 = On/Off remote contact 2 = EHS Alarm input	0	1
5126	Flow switch input, terminals 26-27: 0 = Disable 1 = Enable	1	0
5150	Enable DHW 3-way valve: Terminal 50-51-52 0 = Disable 1 = Enable	0	1

Selecting The Correct Cooling Option

The following system configurations are for systems that provide both heating and cooling. Depending on the type of cooling system or part of the country the home is in, the cooling settings need to be selected to ensure they are suitable.

The following system types are 3-A & 3-B for heating and cooling without domestic hot water heating & 4-A & 4-B for heating and cooling with domestic hot water heating. The A & B of these systems are the different cooling set points which are explained further below.

A – Cooling settings: Fixed or weather compensated set point

These settings are optimal for systems that suit lower chilled water temperatures and where condensation is not as much of a concern, the examples for this are:

- Fan coil systems where condensation is removed via condensate drains.
- In slab underfloor cooling systems in regions of lower summer humidity levels – typically this is the South Island region.
- These settings will maximise cooling performance over efficiency and suit situations where this is the most important factor.

B – Cooling settings: Weather compensated set point with humidity compensation

These settings are suitable for systems that need to have weather and humidity compensated flow temperatures to improve efficiency and/or reduce the risk of the formation of condensation, the examples for this are:

- Variotherm Variocomp or Module panel radiant cooling systems.
- In slab underfloor cooling systems in regions of higher summer humidity levels – typically this applies to the North Island region.
- These settings will maximise cooling efficiency over performance and suit systems where this is the most important factor.

Note: For radiant cooling systems the CHNZ SmartOne thermostat must be used with the dew point check function enabled. The floor probe must be installed in conduit in the floor slab for an underfloor heating system or securely attached and insulated to a return pipe on a Variocomp/Modulepanel system.

System 3-A: Heat Pump Switched On/Off by Room Thermostat(s) Heating & Type A Cooling

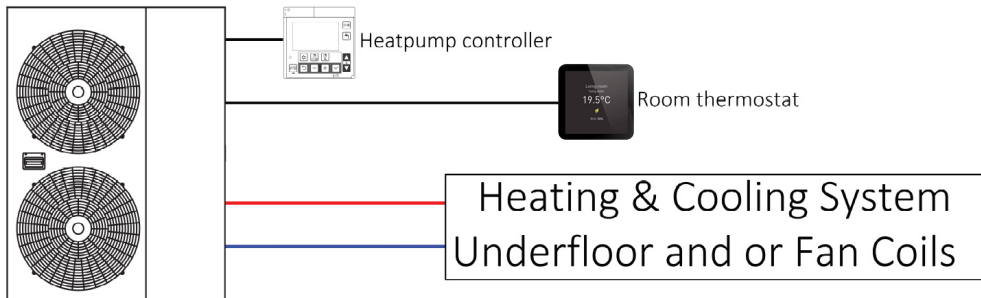

Parameter	Description	Value	
		Default	Set To
2101	Flow temperature set point for heating 35 to 45 underfloor (depending on floor covering) 60 – radiators	45	See description
2120	Cooling, enable outgoing water set point 0 = Fixed set point for fan coils 1 = Climatic curve enabled for underfloor	0	See description
2122	Maximum outgoing water temperature in Cooling mode	20	15
2123	Minimum outgoing water temperature in Cooling mode	18	10
2124	Minimum outdoor air temperature corresponding to maximum Outgoing water temperature	25	20
2125	Maximum outdoor air temperature corresponding to maximum Outgoing water temperature	35	30
4301	Start temperature of frost protection on room air temperature	14	5
5120	Terminal 20-21: On/Off remote contact or EHS Alarm input 0 = Disable (Remote controller only) 1 = On/Off remote contact 2 = EHS Alarm input	0	1
5124	Terminal 24-25: Heating/Cooling mode remote contact 0 = Disable (Remote Controller Only) 1 = Cooling is CLOSE contact, Heating is OPEN contact 2 = Cooling is OPEN contact, Heating is CLOSE contact	0	1
5126	Flow switch input, terminals 26-27: 0 = Disable 1 = Enable	1	0

System 3-B: Heat Pump Switched On/Off by Room Thermostat(s) Heating & Type B Cooling

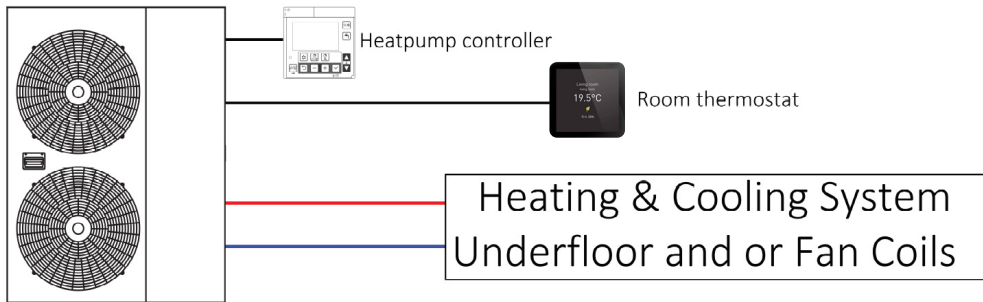

Parameter	Description	Value	
		Default	Set To
2101	Flow temperature set point for heating 35 to 45 underfloor (depending on floor covering) 60 – radiators	45	See description
2120	Cooling, enable outgoing water set point 0 = Fixed set point 1 = Climatic curve enabled	0	1
2122	Maximum outgoing water temperature in Cooling mode	20	15
2123	Minimum outgoing water temperature in Cooling mode	18	10
2124	Minimum outdoor air temperature corresponding to maximum Outgoing water temperature	25	20
2125	Maximum outdoor air temperature corresponding to maximum Outgoing water temperature	35	30
4301	Start temperature of frost protection on room air temperature	14	5
5117	Terminal 17-18: Humidity sensor 0 = Disable 1 = Enabled	0	1

System 3-B continues on the next page

System 3-B: Heat Pump Switched On/Off by Room Thermostat(s) Heating & Type B Cooling continued

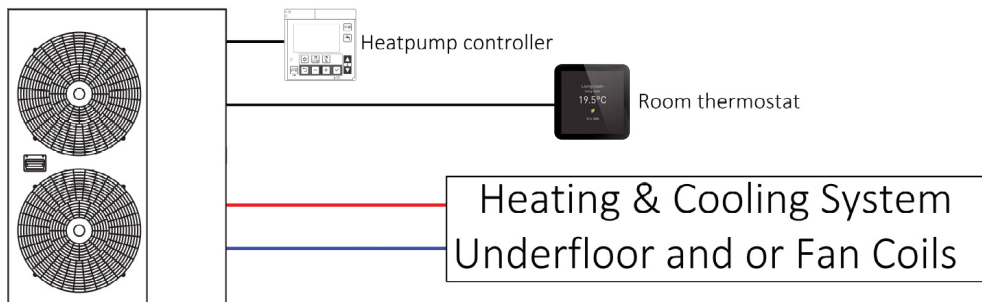

Parameter	Description	Value	
		Default	Set To
5120	Terminal 20-21: On/Off remote contact or EHS Alarm input 0 = Disable (Remote Controller Only) 1 = On/Off remote contact 2 = EHS Alarm input	0	1
5124	Terminal 24-25: Heating/Cooling mode remote contact 0 = Disable (Remote Controller Only) 1 = Cooling is CLOSE contact, Heating is OPEN contact 2 = Cooling is OPEN contact, Heating is CLOSE contact	0	1
5126	Flow switch input, terminals 26-27: 0 = Disable 1 = Enable	1	0

Note: While setting up this system and the thermostat, the 0-10V output from the thermostat will drop on and off causing an L5 error on the heat pump. While this may not clear immediately, after a few minutes the fault can be reset and heat pump operation will resume.

System 4-A: Heat Pump Switched On/Off by Room Thermostat(s) Heating & Type A Cooling + DHW

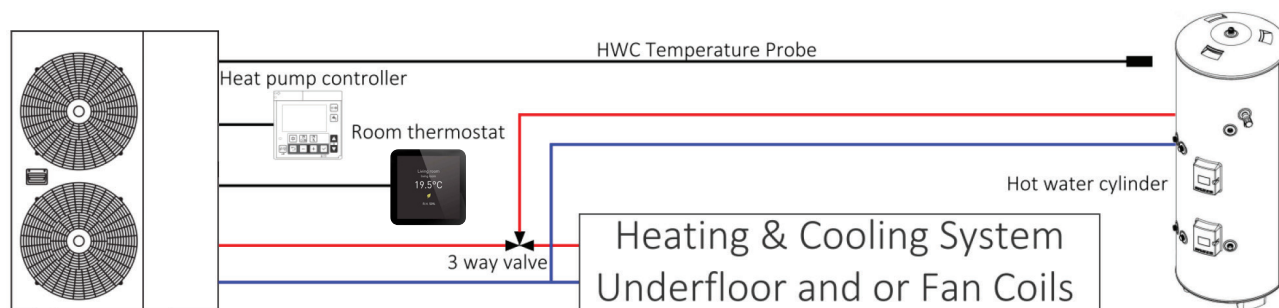

Parameter	Description	Value	
		Default	Set To
2101	Flow temperature set point for heating 35 to 45 underfloor (depending on floor covering) 60 – radiators	45	See description
2120	Cooling, enable outgoing water set point 0 = Fixed set point for fan coils 1 = Climatic curve enabled for underfloor	0	See description
2122	Maximum outgoing water temperature in Cooling mode	20	15
2123	Minimum outgoing water temperature in Cooling mode	18	10
2124	Minimum outdoor air temperature corresponding to maximum Outgoing water temperature	25	20
2125	Maximum outdoor air temperature corresponding to maximum Outgoing water temperature	35	30
3101	0 = DHW is available 1 = DHW is available, and priority DHW over space heating	0	1
3111	DHW set temperature (of water in cylinder)	50	50
4301	Start temperature of frost protection on room air temperature	14	5
5107	Enable DHW sensor: Terminal 7-8 0 = Disable 1 = Enable	0	1

System 4-A continues on the next page

System 4-A: Heat Pump Switched On/Off by Room Thermostat(s) Heating & Type A Cooling + DHW continued

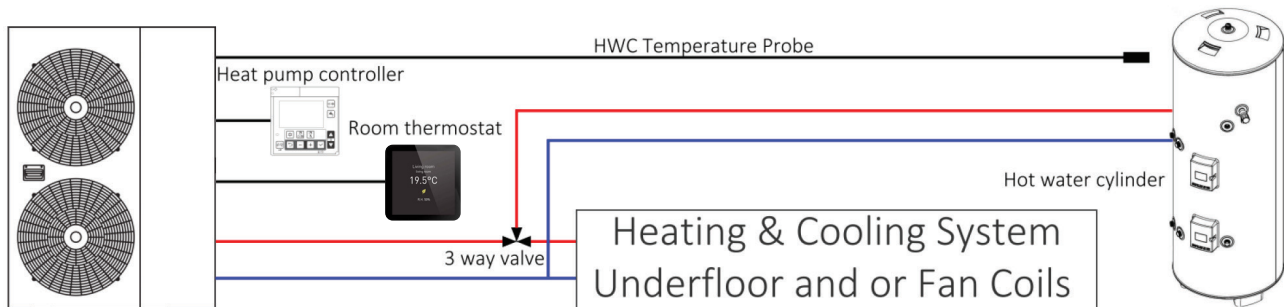

Parameter	Description	Value	
		Default	Set To
5120	Terminal 20-21: On/Off remote contact or EHS Alarm input 0 = Disable (Remote controller only) 1 = On/Off remote contact 2 = EHS Alarm input	0	1
5124	Terminal 24-25: Heating/Cooling mode remote contact 0 = Disable (Remote Controller Only) 1 = Cooling is CLOSE contact, Heating is OPEN contact 2 = Cooling is OPEN contact, Heating is CLOSE contact	0	1
5126	Flow switch input, terminals 26-27: 0 = Disable 1 = Enable	1	0
5150	Enable DHW 3-way valve: Terminal 50-51-52 0 = Disable 1 = Enable	0	1

System 4-B: Heat Pump Switched On/Off by Room Thermostat(s) Heating & Type B Cooling + DHW

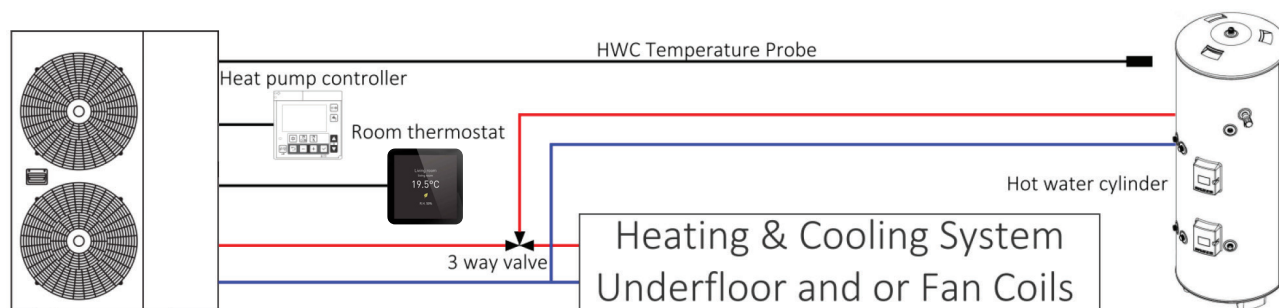

Parameter	Description	Value	
		Default	Set To
2101	Flow temperature set point for heating 35 to 45 underfloor (depending on floor covering) 60 – radiators	45	See description
2120	Cooling, enable outgoing water set point 0 = Fixed set point 1 = Climatic curve enabled	0	1
2122	Maximum outgoing water temperature in Cooling mode	20	15
2123	Minimum outgoing water temperature in Cooling mode	18	10
2124	Minimum outdoor air temperature corresponding to maximum Outgoing water temperature	25	20
2125	Maximum outdoor air temperature corresponding to maximum Outgoing water temperature	35	30
3101	0 = DHW is available 1 = DHW is available, and priority DHW over space heating	0	1
3111	DHW set temperature (of water in cylinder)	50	50
4301	Start temperature of frost protection on room air temperature	14	5

System 4-B continues on the next page

System 4-B: Heat Pump Switched On/Off by Room Thermostat(s) Heating & Type B Cooling + DHW continued

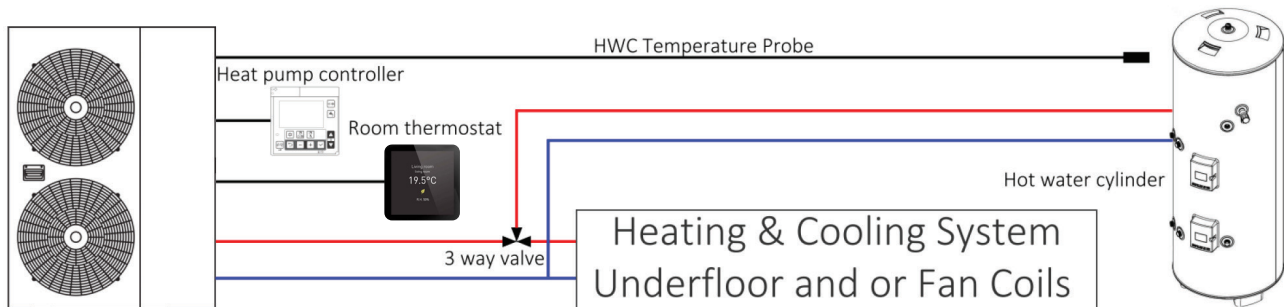

Parameter	Description	Value	
		Default	Set To
5107	Enable DHW sensor: Terminal 7-8 0 = Disable 1 = Enable	0	1
5117	Terminal 17-18: Humidity sensor 0 = Disable 1 = Enable	0	1
5120	Terminal 20-21: On/Off remote contact or EHS Alarm input 0 = Disable (Remote controller only) 1 = On/Off remote contact 2 = EHS Alarm input	0	1
5124	Terminal 24-25: Heating/Cooling mode remote contact 0 = Disable (Remote Controller Only) 1 = Cooling is CLOSE contact, Heating is OPEN contact 2 = Cooling is OPEN contact, Heating is CLOSE contact	0	1
5126	Flow switch input, terminals 26-27: 0 = Disable 1 = Enable	1	0
5150	Enable DHW 3-way valve: Terminal 50-51-52 0 = Disable 1 = Enable	0	1

Note: While setting up this system and the thermostat, the 0-10V output from the thermostat will drop on and off causing an L5 error on the heat pump. While this may not clear immediately, after a few minutes the fault can be reset and heat pump operation will resume.

System Operational Checks

Once the heat pump is set up, it is a very good idea to check that everything works as intended and that the heat pump starts and stops when it should in response to the controls used, and there is a good flow rate at the manifolds and radiators get hot.

Checking Sensor Values

Ensure these temperatures are recorded when the heat pump is running steadily.

Parameter	Function Description	Display Unit
01 00	Return water temperature	1°C
01 09	Flow water temperature	1°C
01 06	Outdoor air temperature	1°C
01 31	DHW sensor temperature	1°C

Alternatively these can be viewed from the outdoor units terminal PCB.

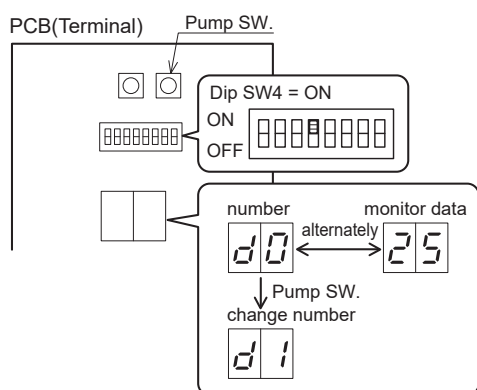

Display on PCB (Terminal) display

- Turn On the dip SW4 on the PCB (Terminal) to display the monitor number and monitor data alternately.
- Push the Pump SW, of the PCB (Terminal) to switch the display number alternately.
- To return to normal display, turn Off the Dip SW4.

Number	Parameter	Default	Minimum	Maximum	Unit
d0	01 00	-	-20	100	1°C
d1	01 01	-	0	200	1Hz
d2	01 02	-	-20	150	1°C
d3	01 03	-	0	9900	100W
d4	01 04	-	0	1000	10rpm
d5	01 05	-	-20	100	1°C
d6	01 06	-	-20	100	1°C
d7	01 07	-	0	9900	100rpm
d8	01 08	-	-20	100	1°C
d9	01 09	-	-20	100	1°C

Additional Settings

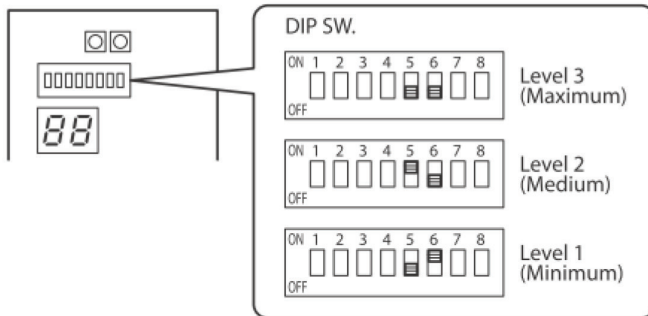

If an excessive flow rate occurs due to low pressure loss of the circulating loop, adjust the Main water pump speed so that the flow rate is reduced.

Using the Dip switches on the PCB (Terminal) – as noted on the above diagram, 3-Pump speeds are available.

Be aware that an excessively low flow rate may cause problems including diminished capacity, poor circulation, or system errors.

At the factory shipment, both SW5 and SW6 are Off, which means the pump will operate at maximum.

Resetting Errors

The procedure to reset the error display differs between error codes and there are 3 ways to reset: Auto, Power Off, and Manual. See “List of Errors codes” in the Chofu installation manual for the procedure to reset each error code.

- Auto:** Automatically. Once it returns to normal condition, the error will be reset. When the unit stops, it may not be possible to reset automatically. Then, it needs to be reset manually.
- Power Off:** Manually. If Heat pump unit returns to normal condition, turn Off the power supply once and turn On again, then the error will be reset.
- Manual:** Manually. To reset the error, press – and + button of the Master Remote controller at the same time for 3 seconds, or press Reset SW on the PCB (Terminal).

If the error persists please contact our technical aftersales team for assistance with the fault: aftersalestechnical@centralheating.co.nz or call 0800 357 1233

New Zealand's Experts

The combination of our skills, products, experience and people, make us New Zealand's experts in the central heating industry. We take pride in supplying the right heating system or products for our customers' specific functionality and budget requirements so that at the end of every project, both our customers and their clients are delighted—and warm.

Central Heating New Zealand: the experts in hydronic central heating and cooling products, systems and design.

Keep up to date with the latest products and promotions on our mobile-friendly website trade.centralheating.co.nz.

We have tailored our website to make it easier for you to search products, checkout faster, store multiple shipping addresses and view your past orders.



Find out more at centralheating.co.nz

52 Pilkington Way, Wigram, Christchurch, 8042

info@centralheating.co.nz

0800 357 1233

